

Left-side view

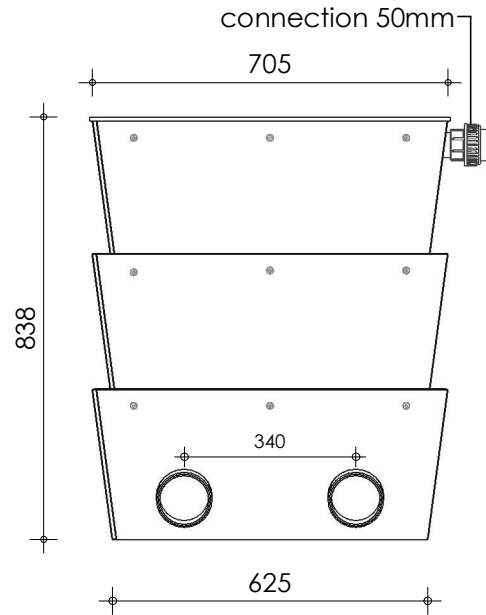

Front view

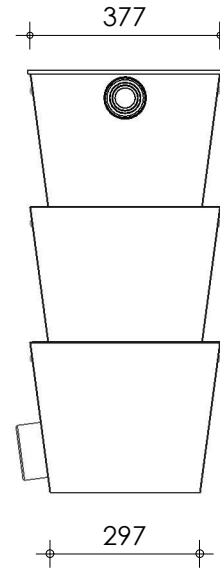

Right-side view

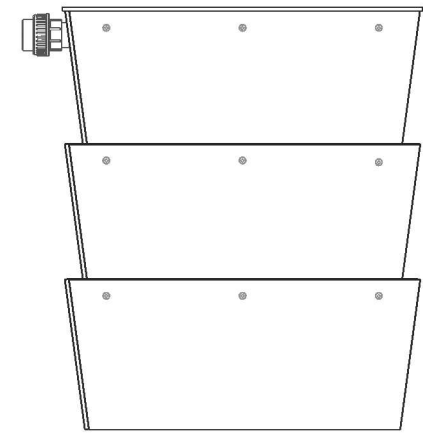

Rear view

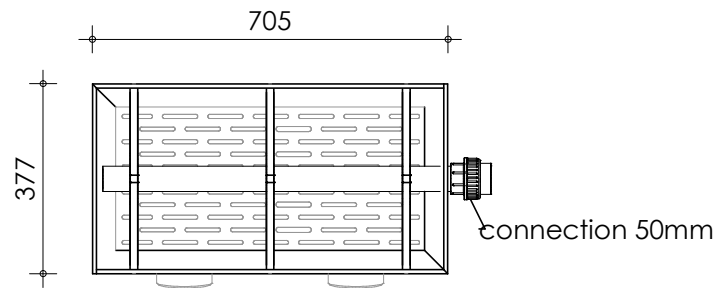

Top view

Filter media

Bacteria House - 308 rods (2 boxes)

**description:**  
TF60 - Trickle filter 2x110

**scale :**  
1 : 15

**date/version :**  
v.3